

TOP VIEW OF BOX

NOTES :

1. LOGO: COMES IN A VARIETY OF STANDARD LOGOS. IE: "ELECTRIC", "WATER", "COMMUNICATIONS". CUSTOM LOGOS CAN BE PRODUCED. CONTACT CUSTOMER SERVICE FOR MORE LOGO INFORMATION (ORDERS@MACLEANHIGHLINE.COM)
2. FOR KNOCKOUTS, MOUSE HOLES, OR ANY OTHER SPECIAL REQUESTS. PLEASE CONTACT CUSTOMER SERVICE. (ORDERS@MACLEANHIGHLINE.COM)
3. CUSTOM PART NUMBER SHALL BE ASSIGNED FOR CUSTOMER SPECIFIC REQUIREMENTS.
4. ALL WEIGHTS ARE APPROXIMATE.
5. PRODUCT ASSEMBLY LABELING LISTED BELOW:

SIZE	TIER RATING	LOGO	HARDWARE
CHA243624	S= TIER 8 H = TIER 15	B00 = BLANK FLAT TOP E00 = ELECTRIC M00 = COMMUNICATIONS 300 = 2"x8"x1/4" DEEP BLANK ??? = CUSTOM LOGO OPTION	1 = 3/8" PENTA BOLT 2 = 3/8" HEX BOLT

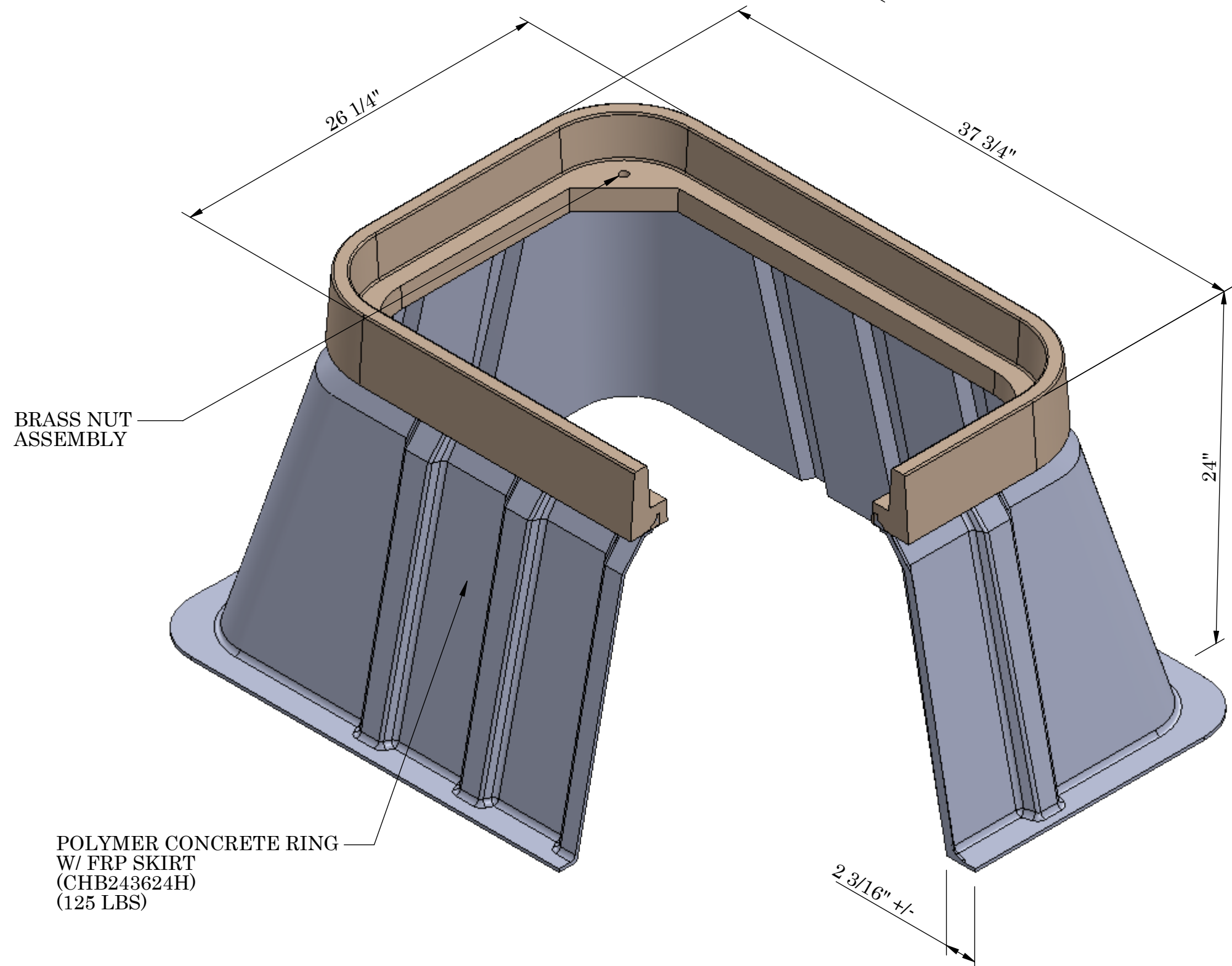
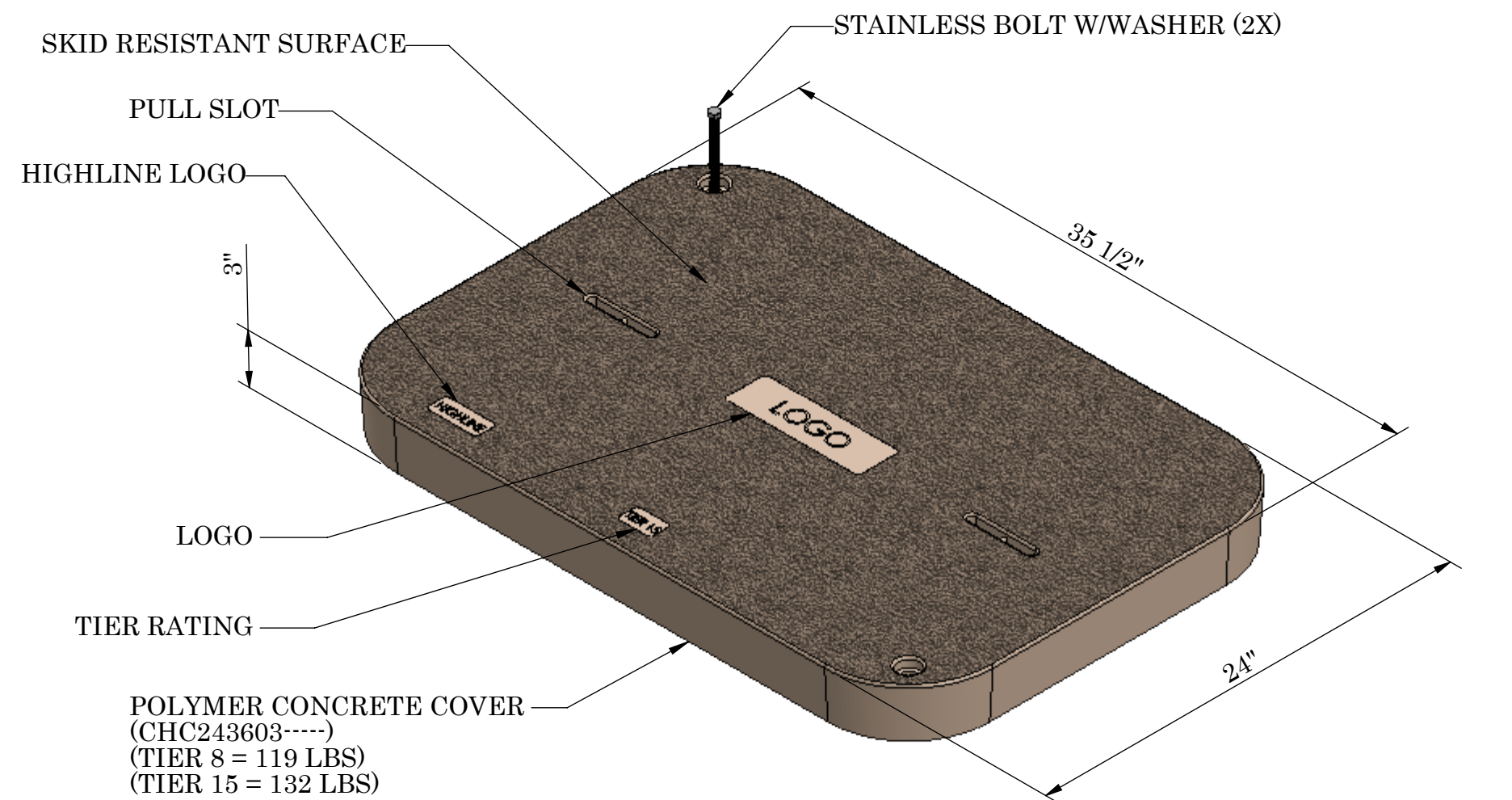
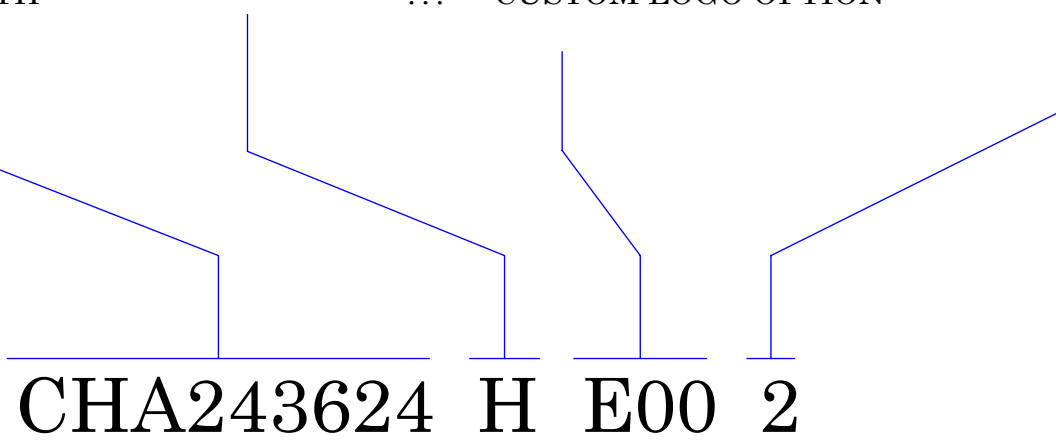

ISOMETRIC VIEW

This drawing contains confidential information that is the property of MacLean Power, L.L.C. ("MacLean"). Use of MacLean's confidential information without MacLean's express written consent is strictly prohibited and may expose you to legal liability. If you believe that you received this material in error, please destroy it or return it to "MacLean Power, L.L.C., 481 MUNN ROAD SUITE 300, FORT MILL, SC 29715, USA."



DRAWING NUMBER: CHA243624-----	DO NOT SCALE DRAWING
SHEET NAME: 1 OF 1	CAD GENERATED DRAWING DO NOT MANUALLY UPDATE
DRAWING DESCRIPTION: TIER 8 (S) 8,000lbs TIER 15 (H) 15,000lbs	DESIGN DATE: 10/6/17
DRAWING SCALE: NTS	DRAWN BY: CB
FILE NAME: CHA243624H0002 9-1-17	CHECKED: WHO
	APPROVED: WHO
	REV: A
	REV DATE: 10/6/17