

THE INFORMATION CONTAINED IN THIS DRAWING IS THE SOLE PROPERTY OF HIGHLINE. ANY REPRODUCTION IN PART OR WHOLE WITHOUT THE WRITTEN PERMISSION OF HIGHLINE IS PROHIBITED.

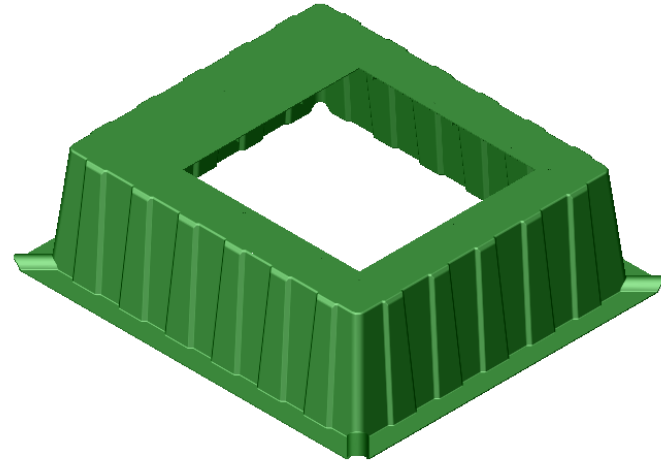

3/8" NUTSERTS

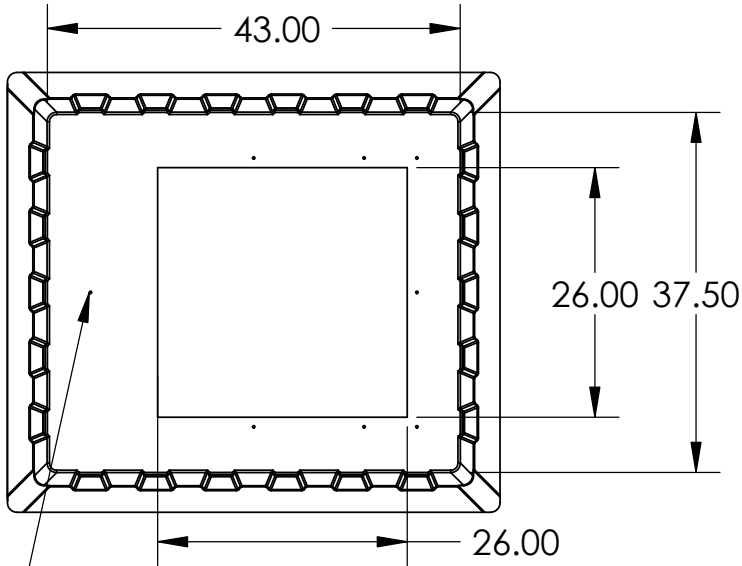
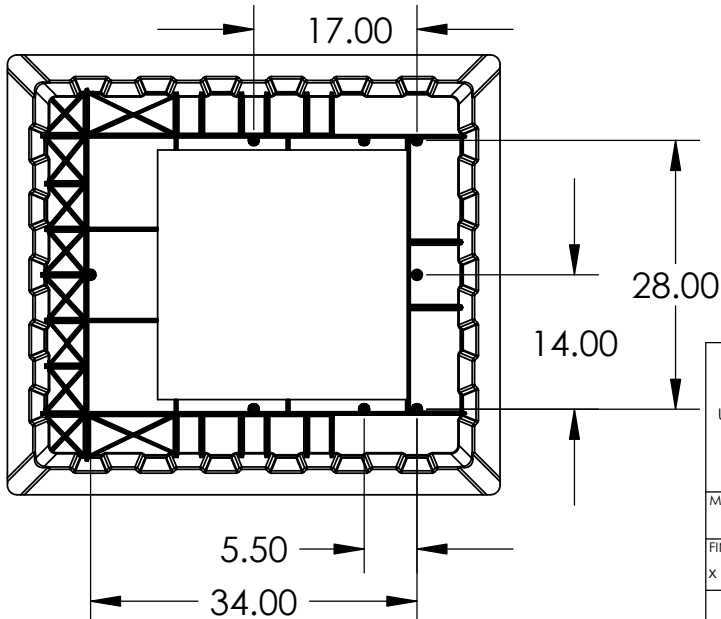
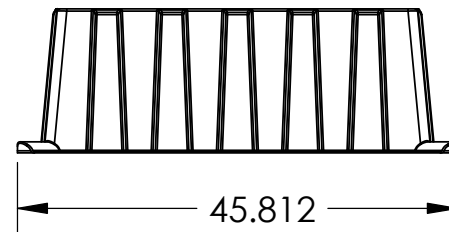

UNLESS OTHERWISE SPECIFIED DIMENSIONS ARE IN INCHES	CAD GENERATED DRAWING, DO NOT MANUALLY UPDATE		<b>HIGHLINE PRODUCTS</b>	
	APPROVALS	DATE	Waltham, MA 02453-1480	
	DRAWN: KAJ	22JUN04	HL374315-2626 TRANSFORMER BOX PAD	
MATERIAL	COMPRESSION MOLDED FIBERGLASS		SIZE	DWG. NO.
FINISH	X		A	REV. --
DO NOT SCALE DRAWING			SCALE: 1:20	CAD FILE: HL374315-X
			SHEET: 1 OF 1	