

THE INFORMATION CONTAINED IN THIS DRAWING IS THE SOLE PROPERTY OF HIGHLINE. ANY REPRODUCTION IN PART OR WHOLE WITHOUT THE WRITTEN PERMISSION OF HIGHLINE IS PROHIBITED.

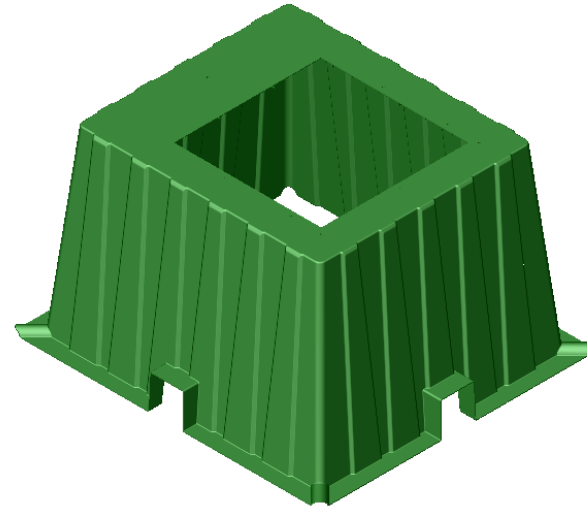

3/8" NUTSERTS

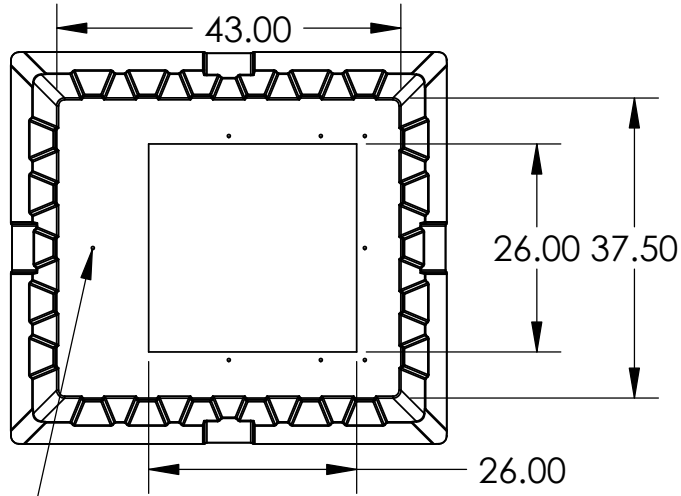
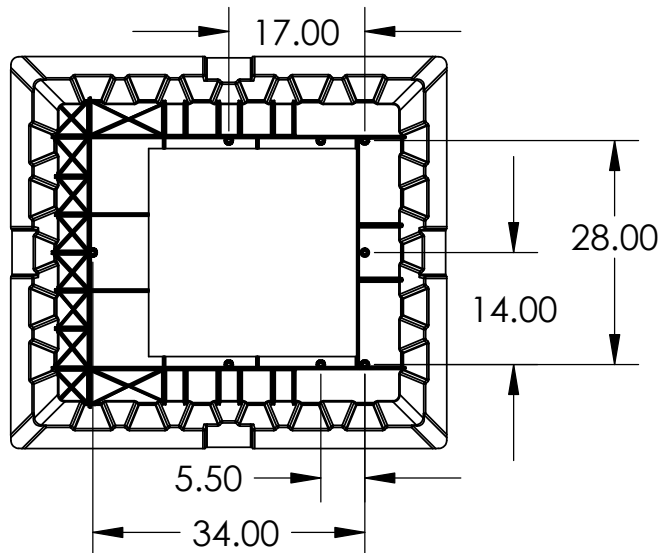
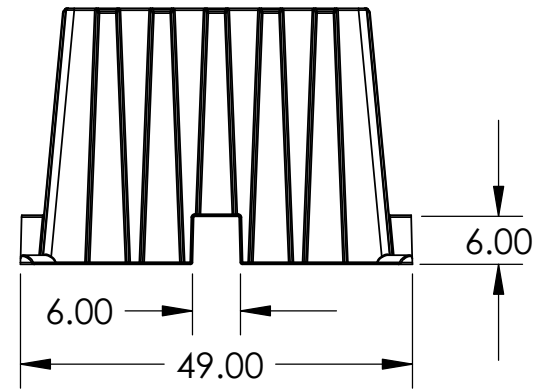
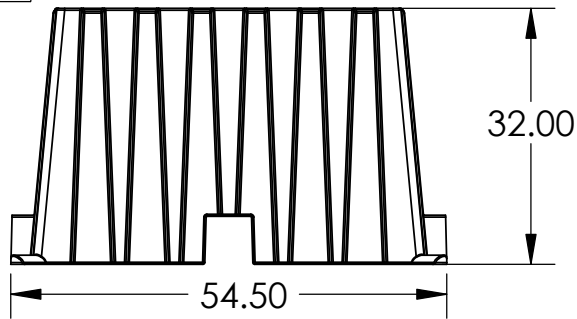

UNLESS OTHERWISE SPECIFIED DIMENSIONS ARE IN INCHES	CAD GENERATED DRAWING, DO NOT MANUALLY UPDATE		HIGHLINE PRODUCTS Waltham, MA 02453-1480		
	APPROVALS	DATE			
	DRAWN: KAJ	22JUN04	HL374332-2626 TRANSFORMER BOX PAD		
CHECKED					
MATERIAL	COMPRESSION MOLDED FIBERGLASS			SIZE A	
FINISH	X				
DO NOT SCALE DRAWING			SCALE: 1:24	CAD FILE: HL374332-X	REV. --
			SHEET: 1 OF 1		