

THE INFORMATION CONTAINED IN THIS DRAWING IS THE SOLE PROPERTY OF HIGHLINE. ANY REPRODUCTION IN PART OR WHOLE WITHOUT THE WRITTEN PERMISSION OF HIGHLINE IS PROHIBITED.

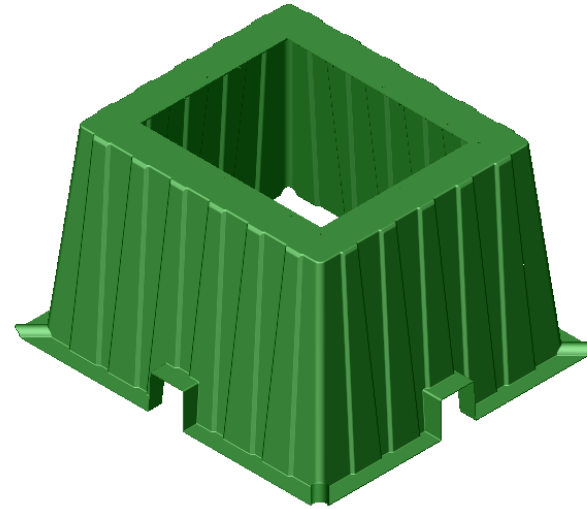

3/8" NUTSERTS

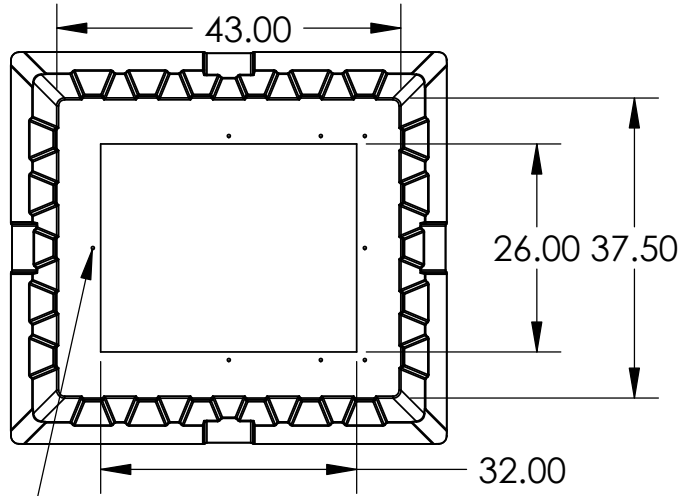
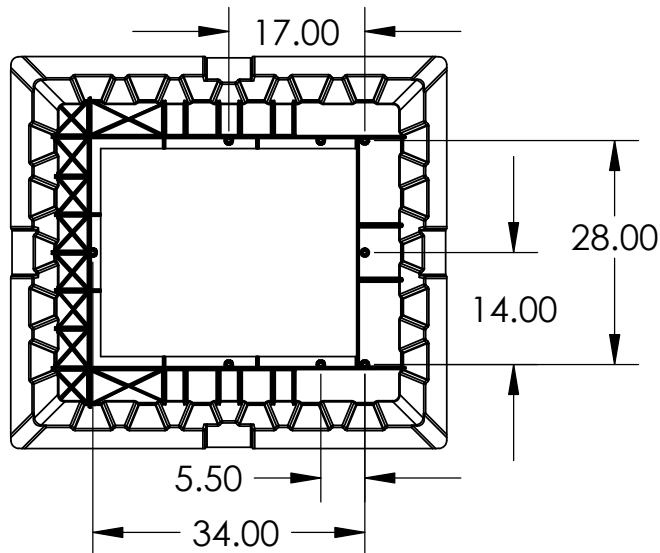
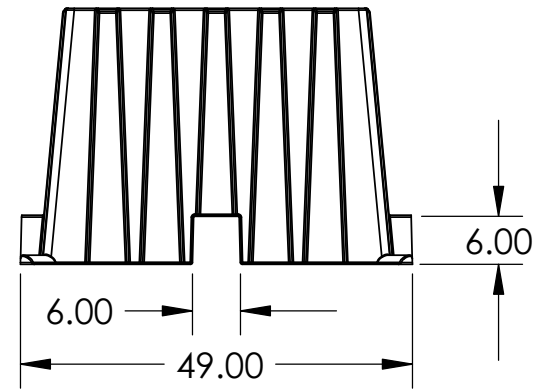
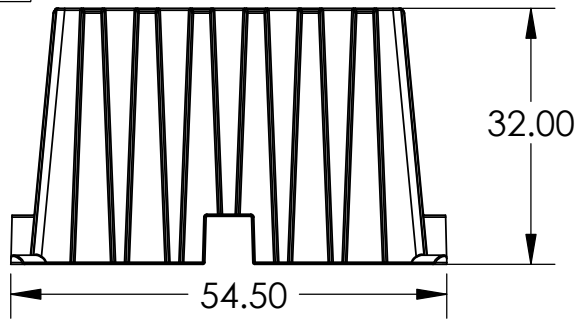

UNLESS OTHERWISE SPECIFIED DIMENSIONS ARE IN INCHES	CAD GENERATED DRAWING, DO NOT MANUALLY UPDATE		HIGHLINE PRODUCTS	
	APPROVALS	DATE	Waltham, MA 02453-1480	
	DRAWN: KAJ	22JUN04	HL374332-2632 TRANSFORMER BOX PAD	
MATERIAL	COMPRESSION MOLDED FIBERGLASS		REV. --	
FINISH	X		SIZE A	DWG. NO.
DO NOT SCALE DRAWING			SCALE: 1:24	CAD FILE: HL374332-X
			SHEET: 1 OF 1	